

# DEVELOPING AND EVALUATING A HYBRID QUANTUM CONVOLUTIONAL NEURAL NETWORK FOR ENHANCED IMAGE CLASSIFICATION

Fabiha Shahzad<sup>1</sup>, Dr Amnah Firdous<sup>\*2</sup>, Shabbar Khan Saddozai<sup>3</sup>, Manahil Khan<sup>4</sup>,  
Muniba Saleem<sup>5</sup>

<sup>1,2,3,4,5</sup>Department of CS&IT The Government Sadiq College Women University Bahawalpur

[fabihaansar000@gmail.com](mailto:fabihaansar000@gmail.com) , [amnah@gscwu.edu.pk](mailto:amnah@gscwu.edu.pk) , [shabbarkhan12@gmail.com](mailto:shabbarkhan12@gmail.com),  
[manahil.khan7512@gmail.com](mailto:manahil.khan7512@gmail.com), [muniba@gscwu.edu.pk](mailto:muniba@gscwu.edu.pk)

DOI: <https://doi.org/>

## Keywords

Quantum Convolutional Neural Networks, MNIST Dataset, CIFAR-10 Dataset, Quantum Computing, Hybrid Quantum-Classical Convolutional Neural Network

## Article History

Received on 20 April 2026

Accepted on 23 May 2026

Published on 27 May 2026

Copyright @Author

Corresponding Author: \*

Dr Amnah Firdous \*

## Abstract

*In image classification problems, the size of the space and parameter increase are limiting factors to implement a classical convolutional neural network (CNN) on resource-constrained systems. This paper investigates hybrid quantum-classical learning models to use CNN as a space-saving alternative. Two hybrid quantum neural network architectures are designed, namely HQNN-Parallel and HQNN-Quanv. HQNN-Parallel is one of such quantum neural networks: it is a hybrid network consisting of a classical convolutional feature extractor and parallel four-qubit quantum circuits in the hybrid, amplitude encoding, trainable rotation gate, CNOT-based entanglement, and Pauli-Z measurement. HQNN-Quanv proposes to use a quantum convolutional layer to help in feature transformation and image-resolution reduction. Tested on MNIST, Medical MNIST, and CIFAR-10 datasets and comes with metrics including accuracy, loss, precision, recall, F1 score, and trainable parameters. HQNN-Parallel on MNIST is much more accurate (99.21%) than the classical CNN baseline, which is approximately 100,000 parameters. The accuracy of the hybrid model is 84.11 per cent for CIFAR-10, compared to the classical CNN baseline accuracy of 83.12 per cent. The accuracy of the HQNN-Quanv is 99.0 % on MNIST, while the classical CNN has 99.1 % accuracy, and there is a reduction of 74.59 % of parameters in the classical CNN compared to the HQNN-Quanv. The results suggest that competitive accuracy can be obtained with hybrid quantum-classical models, with enhanced parameter efficiency. However, the research is limited in that it is only simulation-based, validating with real devices for noise and no noise. Additional research will be conducted via noise-model experiments, statistical testing (repeated experiments), and hardware construction to see if they provide an actual advantage in the real world.*

## 1. INTRODUCTION

Image classification is a key and highly dynamic area of computer vision with wide-ranging applications in many domains, including medical imaging, remote sensing, and autonomous systems. Although traditional Convolutional Neural Networks (CNNs) have achieved remarkable success in image classification, they still have several limitations, such as the requirement for computational efficiency and the ability to handle large-scale datasets as they increase in volume. (Zhang & Lu, 2024) With this increasing complexity, new ways to improve the performance and scalability of image classification systems need to be explored. In this regard, a new paradigm called quantum computing (QC) has surfaced as a promising way to solve the classical CNNs' limitations, as it promises to enable more powerful computational operations. In this context, a new paradigm called quantum computing (QC) has arisen as a promising means to overcome the limitations of classical CNNs, as it allows the development of more powerful computational operations. (Zeng et al., 2022) Quantum models can use quantum mechanical phenomena like superposition and entanglement to hold a tremendous

amount of information and carry out complex calculations in record time. The development of Quantum Convolutional Neural Networks (QCNNs) and Hybrid Quantum-Classical Convolutional Neural Networks (HQCNNs) is also emerging, which are classical CNN networks with the addition of quantum circuits to leverage their strengths. (Yousif et al., 2024).

This field is still in the research stage and is actively researching various architectures of HQCNNs and their capabilities and limitations. The initial neural network innovations, imitating the visual neurons of the human brain, laid the groundwork for CNNs and were represented by early models such as LeNet-5 and AlexNet. But the problems like long training duration, high resource requirement, and high complexity still exist for classical CNNs. (West et al., 2023) CNN can be composed of convolutional layers, pooling layers, and a fully connected layer. Figure 1.1 shows the architecture of CNNs, where the flow of data is controlled from convolution and pooling to classification. Meanwhile, quantum machine learning (QML) and quantum-inspired neural networks have been mentioned for their potential to enhance image compression and feature

extraction, with a potential for performance exceeding classical techniques. This encompasses some quantum algorithms such as Amplitude Estimation, Quantum Fourier Transform, models including Quantum Perceptrons (QPs), Quantum Autoencoders (QAEs), Quantum Boltzmann Machines (QBM), Quantum Hopfield Neural Networks (QHNNs), and Quantum Bayesian Networks (QBNs). (Shahi et al., 2022)

Although quantum technologies have been

promising in theory, they are still hindered by the limitations of Noisy Intermediate-Scale Quantum (NISQ) hardware, which can cause errors and noise, affecting the performance and reliability of quantum computers. Solving these problems will need improvements in fault-tolerant quantum hardware and in the development of good training algorithms that are less sensitive to noise. (Sarkar et al., 2025)

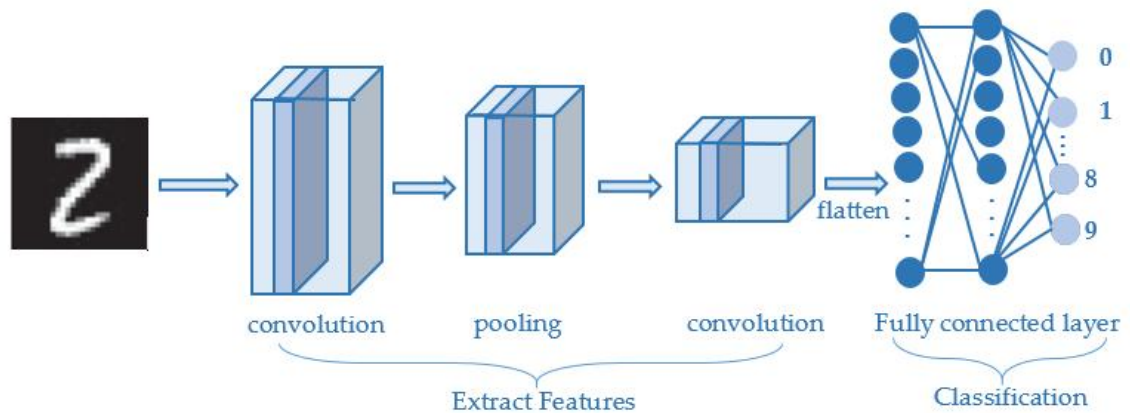

Figure 1 Layered Architecture of CNN

To realize the theoretical quantum advantage and improve the effectiveness of image classification applications, this research will focus on developing and testing new HQCNN architectures. The main aims are the design of a novel HQNN by implementing classical CNN layers along with a quantum processing to

achieve better image classification performance, the development of a quantum convolution layer to minimize

the number of qubits and simplify the model, study the effect of different quantum factors on classification performance, and comparison of the accuracy, speed, and resource efficiency of

the proposed HQNN on the standard image datasets. (Roeseler et al., 2025) The lack of comparison between the small hybrid quantum CNN modules and the classical CNNs on benchmark datasets, both in terms of resource utilization and in terms of reproducibility, is addressed in this work. It suggests the use of multiple small-sized PQC modules (HQNN-Parallel) or many small-sized PQC modules to decrease parameters (HQNN-Quantum). The accuracy, loss, number of parameters, and reductions are reported for assessments of MNIST, Medical MNIST, and CIFAR-10. It also provides a framework for reproducibility and solves problems such as simulation-only results and unavailable results, which can be executed on hardware. (Rifat et al., 2025)

## 2. Related Work

This section provides an overview of the evolution of Hybrid Quantum Convolutional Neural Networks (HQCNNs) for image classification, and how they can enable more efficient, scalable, and pattern recognition and image classification. HQCNNs can be used to improve feature extraction, reduce parameters, speed up training, and decrease energy consumption by

combining quantum circuits with classical CNNs. (Kulkarni et al., 2022) While there are challenges like quantum noise, hardware integration, and the small size of qubits and the high error rates, the opportunities presented by HQCNNs show great promise for capturing complex features, particularly for large datasets and applications in industry. (West et al., 2023) Other works show the feasibility of using HQCNNs on NISQ quantum devices, including models that are capable of high accuracy on MNIST with reduced dimensional encoding and real quantum processors. Classical segmentation and generation of synthetic data, PCA and autoencoders, and ensemble learning have also been integrated with quantum circuits to enhance robustness and generalization. (Ajlouni et al., 2023) Yet, even HQCNNs have issues such as high circuit design cost, flat plateau, hybrid optimization problem, quantum noise, and are not scalable. Several studies use only small or simplified datasets, and it's not easy to determine if quantum models always outperform classical CNNs in more realistic scenarios. (Roeseler et al., 2025)

Superposition, entanglement, and parameterized quantum operations are

shown to enhance image classification using quantum circuits in CNN architectures, as recently demonstrated. State preparation, convolution, pooling, and feature re-encoding are examples of quantum operations that have been implemented using quantum layers, with models like MERA, distributed QCNNs, selective feature re-encoding, and quantum circuit splitting showing promising results on MNIST, Fashion-MNIST, X-ray, MRI, breast cancer, and Alzheimer's datasets. These models can have similar performance to classical CNNs, but with fewer parameters, which is beneficial for medical imaging and resource-constrained environments. (Rifat et al., 2025) This study is an extension of the hybrid quantum-classical image classification technique from medical and benchmark databases to tourism-related imagery. The study investigates whether the quantum-enhanced layers could boost the accuracy, but leave the computational advantage of SqueezeNet intact, as a lightweight classical baseline. It also investigates the application of HQCNNs in the tourism sector, which is a relatively unexplored area. (Potempa & Porebski, 2022)

In the literature, there are also mentions of the impact of noise and hardware errors on Quantum Neural Networks. Due to gate errors, decoherence, and depth of circuits, QNN reliability and learning ability are limited. Researchers have noted a number of limitations, such as the need for more robust training algorithms, fault-tolerant quantum hardware, and better quantum computing techniques. Reflection Equivariant Quantum Neural Networks have also emerged to better extract features that are rotation-invariant, which has been shown to work well on the MNIST benchmark, but hardware and computational constraints are still needed. (Hur et al., 2022)

A few studies have introduced HQCNN models based on Variational Quantum Circuits, Quantum Convolutional layers, Quantum Neural Networks, and Quantum Perceptrons with the aim of enhancing feature extraction and minimizing the complexity of the models. They also tend to perform as well or slightly better than the classical CNNs with fewer filters or neurons. (Friedrich & Maziero, 2024) Yet complex training, NISQ hardware, and scalability problems remain

to make it harder to be more widespread. Future efforts must be directed towards improving the efficiency of quantum circuit design, improving the hardware, optimizing new algorithms, and benchmarking on larger, more complex data sets. (Ajlouni et al., 2023) Classical CNNs have also gained a lot of developments with models like the ZFNet and the NIN, which improve image classification and enable applications such as remote sensing. CNNs are still essential due to their hierarchical architecture, which is capable of extracting complex features and yielding correct classification. There is, however, still a need for more systematic reviews of CNN-based image classification methods to aid future research. (Arthur & Date, 2022)

### **3. Materials and Methods**

This section specifies the experimental pipeline, mathematical formulation, and training procedure in a reproducible way. Only performance values reported in the uploaded manuscript are utilized in the revision; derived resource-efficiency calculations are added if they can be made based on those reported in the manuscript.

#### **3.1 Data Collection and Preprocessing**

There are three benchmark datasets. The MNIST is a controlled handwritten-digit classification benchmark. To test the performance of the model in a medical-image-like setting, it is tested on the Medical MNIST dataset. CIFAR-10 is also provided as a harder natural-image test set that has a larger intra-class variation in both color and image content.

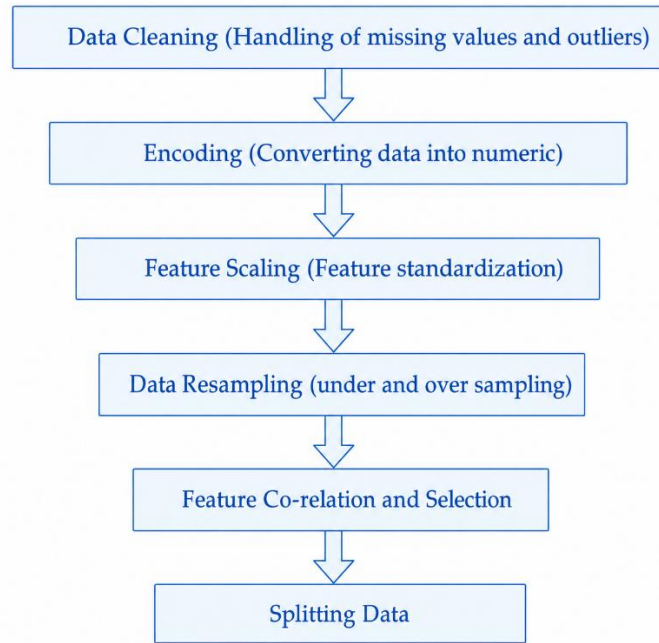

Figure 2 Data Processing Workflow

Table 1 Dataset Role and Reported Results

Dataset	Task	Input handling	Purpose in study	Reported result
MNIST	10-class Handwritten digit classification (HWCD)	Pixel normalization, feature compression before the input of PQC	Primary benchmark for accuracy and parameter efficiency	HQNN-Parallel: 99.21%, HQNN-Quany: 99.0%
Medical MNIST	Link to medical-image classification benchmark	Medical-image feature learning	Robustness check in domain-specific images.	Accuracy above 99% reported
CIFAR-10	10-class object image classification	Normalization and CNN-based feature extraction before	Generalizability check on more complex images	HQNN: 84.11%, CNN: 83.12%

		the quantum module	
--	--	--------------------	--

### 3.2 HQNN-Parallel architecture

HQNN-Parallel is a classical CNN front end and multiple small quantum circuits. Local spatial features are extracted from the image, and the dimensionality of the image representation is reduced in the CNN block. The feature vector is then

flattened and divided into fixed-size chunks of four qubits for four-qubit amplitude encoding. They are classified by a final, classical dense layer with measured expectation values that are concatenated, with each chunk processed by a small PQC.

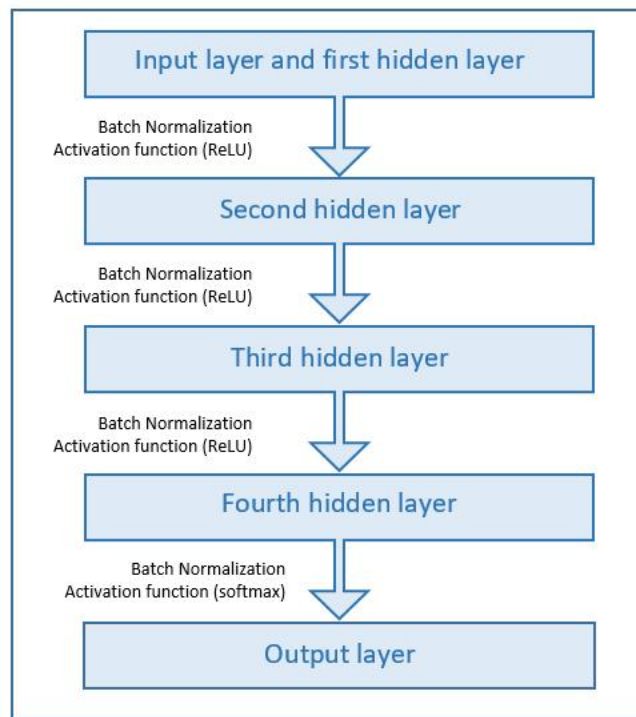

Figure 3 Dense layers before and after hybrid feature transformation

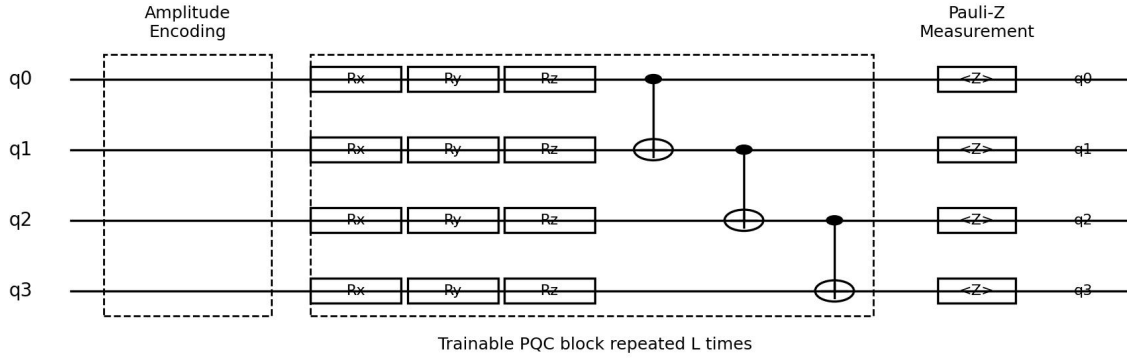

Figure 4 Four-qubit PQC for HQNN with encoding, gates, entanglement, and measurement.

### 3.3 HQNN-Quantum architecture

HQNN-Quantum presents the idea of a quantum circuit used on local image patches, which is referred to as a quantum evolutionary layer. The values of each of the local patches are encoded in the pixel state, then processed by a PQC, and measured to obtain transformed features. These features are later given to the classical layers to be classified. The motivation is to keep the number of classical trainable parameters as low as possible, while keeping the features expressive.

### 3.4 Mathematical formulation

Let  $x$  be a flattened input vector after preprocessing and dimensionality matching. For a four-qubit circuit, the vector must be represented in a  $2^4 = 16$  - dimensional amplitude vector. If necessary,

feature compression or patching is applied before quantum encoding.

$$x'_i = x_i / \sqrt{\sum_j x_j^2}, \quad |\psi(x)\rangle = \sum_{i=0}^{2^n-1} x'_i |i\rangle, \quad n=4. \quad (1)$$

$$U(\theta) = \text{product}_{l=1}^L [U_{\text{ent}}(l) \cdot U_{\text{rot}}(l)(\theta_{l,1})],$$

where  $U_{\text{rot}}$  contains Rx, Ry, and Rz gates and  $U_{\text{ent}}$  contains CNOT gates. (2)

$$q_j = \langle \psi(x) | U(\theta)^\dagger Z_j U(\theta) | \psi(x) \rangle, \quad j=1, \dots, n. \quad (3)$$

$$z = W_c [q_1, q_2, \dots, q_n] + b_c, \quad p(y=k|x) = \exp(z_k) / \sum_{c=1}^C \exp(z_c). \quad (4)$$

$$L_{\text{CE}} = -(1/N) \sum_{i=1}^N \sum_{k=1}^C y_{ik} \log(p_{ik}). \quad (5)$$

$$\text{Parameter reduction (\%)} = ((P_{\text{classical}} - P_{\text{hybrid}}) / P_{\text{classical}}) \times 100. \quad (6)$$

$$\text{Efficiency gain factor} = P_{\text{classical}} / P_{\text{hybrid}}. \quad (7)$$

$$E_p(\rho) = (1-p)\rho + pI/2^n, \quad \text{where } p \text{ is the depolarizing-noise probability.} \quad (8)$$

$$\text{Var}(g_\theta) = (1/R) \sum_{r=1}^R (g_\theta(r) - \text{mean}(g_\theta))^2,$$

used as a barren-plateau diagnostic across R runs. (9)

### 3.5 Training and evaluation algorithm

Algorithm 1 describes the end-to-end training and evaluation process. It is explicitly written in order to make this role

clear to the reviewers of journals and to enhance the reproducibility.

Algorithm 1: Training and evaluation of the proposed HQNN models

Input: Dataset D, class count C, qubits  $n=4$ , PQC depth L, epochs E, learning rate alpha

Output: Trained model M, accuracy, loss, precision, recall, F1-score, and parameter count

1. Split D into training, validation, and test subsets using a fixed random seed.
2. Normalize image pixels and reshape inputs according to the selected model.
3. If using HQNN-Parallel:
  - 3.1. Pass each image through the classical CNN feature extractor.
  - 3.2. Flatten and compress the feature vector into 16-dimensional chunks.
  - 3.3. Encode each chunk using amplitude encoding in a four-qubit PQC.
  - 3.4. Apply trainable  $R_x$ ,  $R_y$ ,  $R_z$  gates and CNOT entanglement.
  - 3.5. Measure Pauli-Z expectation values and concatenate quantum features.
4. If using HQNN-Quantum:
  - 4.1. Extract local image patches.
  - 4.2. Encode each patch into a four-qubit PQC.
  - 4.3. Measure expectation values to form quantum feature maps.
5. Feed the hybrid feature vector into the classical dense classifier.
6. Compute cross-entropy loss and update trainable parameters using backpropagation through the hybrid model.
7. Repeat steps 2-6 for E epochs.
8. Evaluate the trained model on the test set using accuracy, loss, precision, recall, and F1-score.
9. Report trainable parameters, parameter-reduction percentage, and efficiency-gain factor.
10. For journal submission, repeat the full procedure for at least five random seeds and report mean  $\pm$  standard deviation.

### 3.6 Statistical and noise-aware validation protocol

The manuscript uploaded reports one summary accuracy value and a loss value.

The same experiment should be repeated at least 5 independent random seeds to

make a better journal submission. The revised protocol, therefore, specifies what statistical reporting is needed but does not create unobserved results.

Table 2 Statistical and NISQ-aware readiness.

validation items added for journal

Validation item	Recommended reporting method	Reason for inclusion
Repeated-run stability	Report the mean $\pm$ standard deviation for 5 or more seeds	Demonstrates consistency and not accidental difference in accuracy
Significance testing	Compare two different sets of results from repeated runs of the experiment (paired t-test or Wilcoxon signed-rank test)	Conducts a statistical test to determine if 99.21% is meaningful compared to 98.70%.
Noise simulation	Compare depolarizing, bit-flip and phase-flip noise at various probabilities.	Evaluates the robustness of the NISQ before deployment of the hardware
Shot sensitivity	Discuss expectation mode vs finite shot modes (1024, 4096 shots).	Quantifies measurement uncertainty
Barren plateau check	The standard deviation of the gradient change per layer and per training epoch.	Recognizes if it is hard to train the PQC
Hardware backend	If possible, deploy a subset of MNIST to a real or cloud quantum backend.	Discards hardware feasibility from simulator performance

#### 4. Experiments and Results

The performance values listed in this section are those contained in the uploaded manuscript, and additional calculations of derived parameter-efficiency are included. The outputs of repeated runs and the backend logs were not included in the source file, so no additional statistical or hardware results are inserted.

##### 4.1 MNIST performance and parameter efficiency

A comparison of the performance of the MNIST classification in comparison to the parameter efficiency. In the MNIST dataset, HQNN-Parallel outperforms the classical CNN baseline by 99.21% against the baseline's 98.70% accuracy, while having 12,870 trainable parameters compared to the 100,000+ trainable parameters of the classical CNN baseline. The magnitude of the improvement in absolute accuracy is 0.51 percentage points. Most significantly, the hybrid model requires about 87.13%

fewer parameters (7.77x smaller parameter budget). This validates the claim of parameter efficiency, and the magnitude of the accuracy difference should be tested repeatedly with a statistical test.

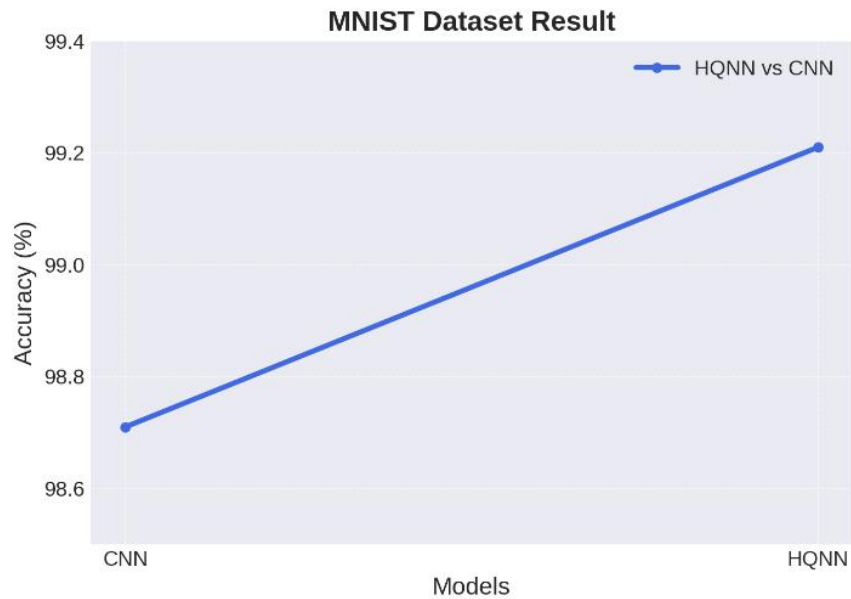

Figure 5 Reported MNIST accuracy comparison between CNN and HQNN.

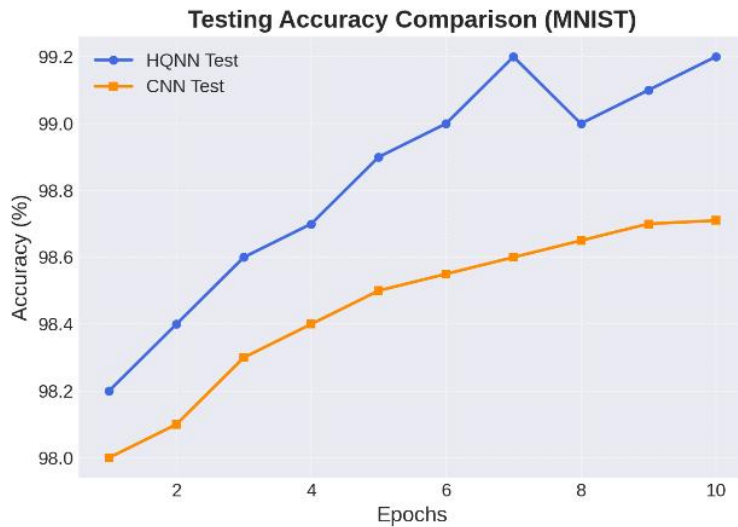

Figure 6 Reported testing-accuracy trend comparison on MNIST.

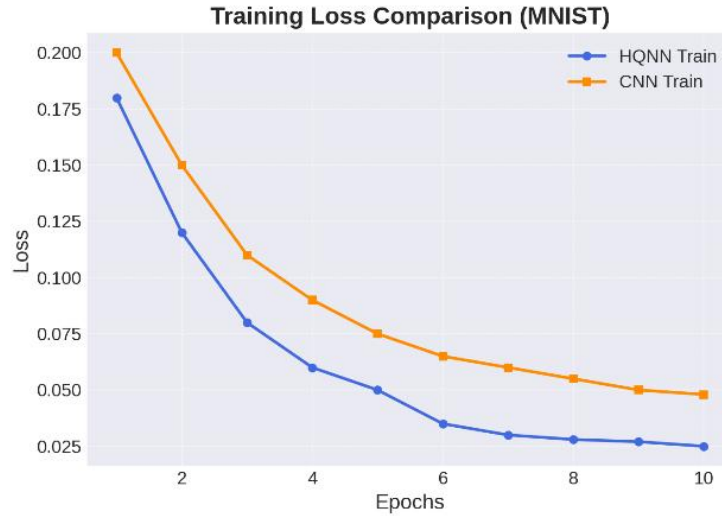

Figure 7 Reported training-loss comparison on MNIST.

#### 4.2 Medical MNIST and CIFAR-10 performance

The authors claim to have reached accuracy rates above 99% on Medical MNIST, which is a medical-image-like benchmark, under the HQNN-Parallel model, suggesting that the hybrid feature representation can perform well on such a benchmark. The hybrid model achieved

84.11% accuracy on CIFAR-10, a more complex dataset than MNIST, with color channels, variations among objects, and a complex background. This is a 0.99 percentage-point gain, but it should be taken with a grain of salt until repeated run variance and noise sensitivity are published.

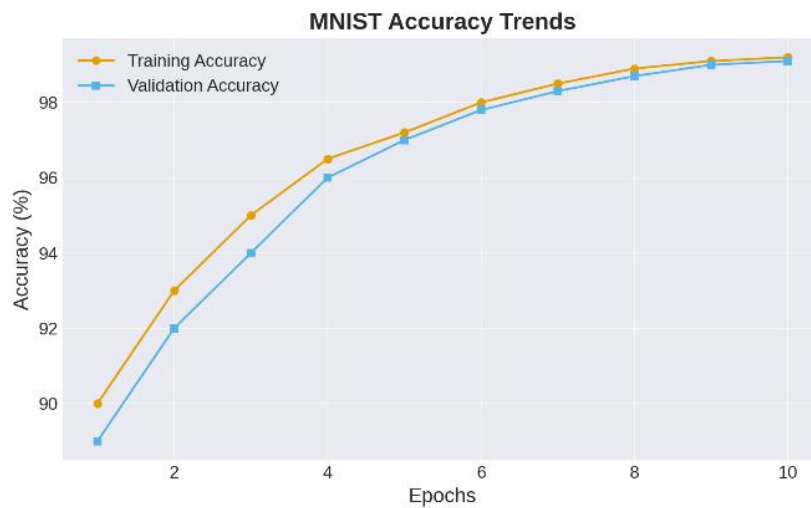

Figure 8 Reported MNIST accuracy trends across epochs.

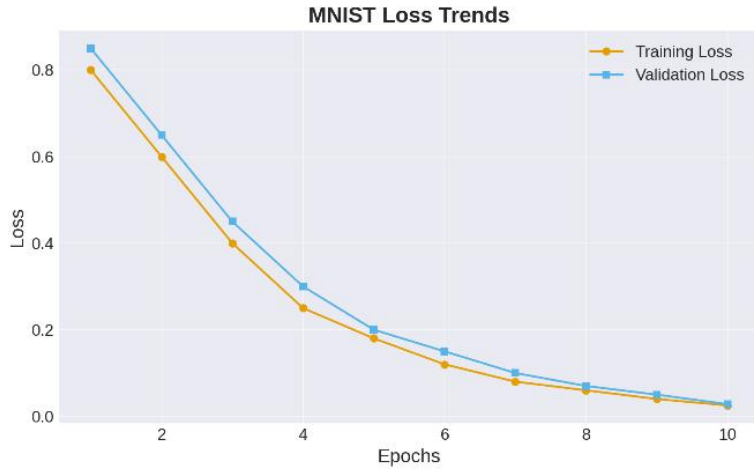

Figure 9 Reported MNIST loss trends across epochs.

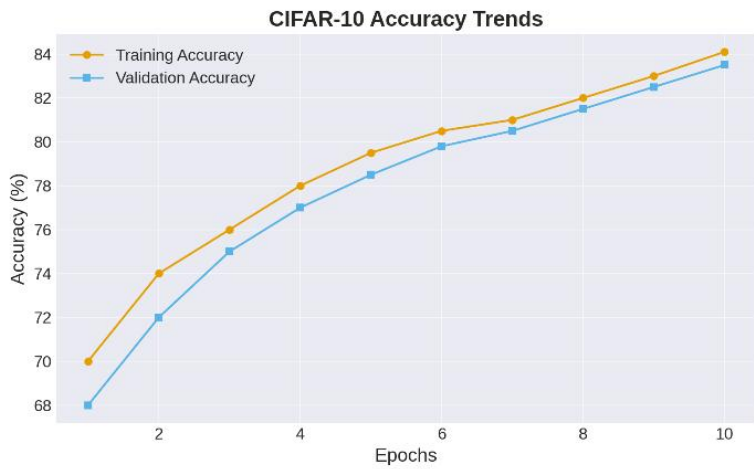

Figure 10 Reported CIFAR-10 accuracy trends across epochs.

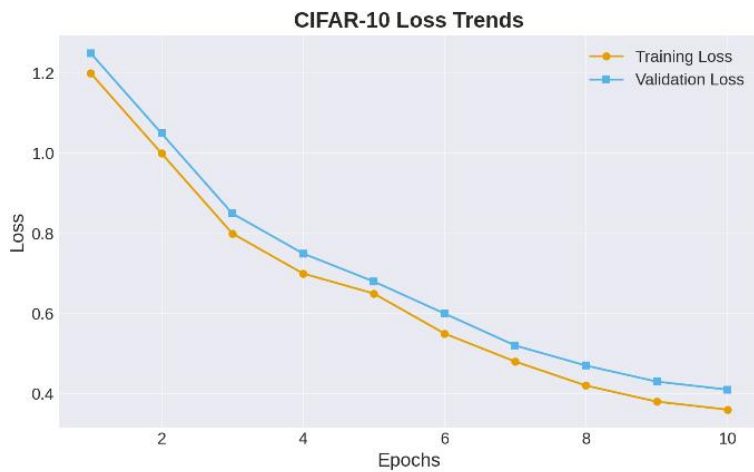

Figure 11 Reported CIFAR-10 loss trends across epochs.

### 4.3 Comparative result summary

Table 3 Reported performance and derived parameter-efficiency comparison.

Dataset	Model	Train loss	Test loss	Accuracy	Parameters	Parameter reduction
MNIST	Classical CNN	0.026	0.448	98.70-98.72%	~100,000	Reference
MNIST	HQNN-Parallel	0.025	0.028	99.21-99.22%	12,870	87.13%, 7.77x fewer
MNIST	Classical CNN for Quany comparison	Not reported	Not reported	99.10%	43,114	Reference
MNIST	HQNN-Quany	Not reported	Not reported	99.00%	10,954	74.59%, 3.94x fewer
Medical MNIST	HQNN-Parallel	Not reported	Not reported	>99%	Not reported	Not computable from available data
CIFAR-10	Classical CNN	0.366	0.549	83.12%	Not reported	Not computable from available data
CIFAR-10	HQNN-Parallel	0.386	0.521	84.11%	Not reported	Not computable from available data

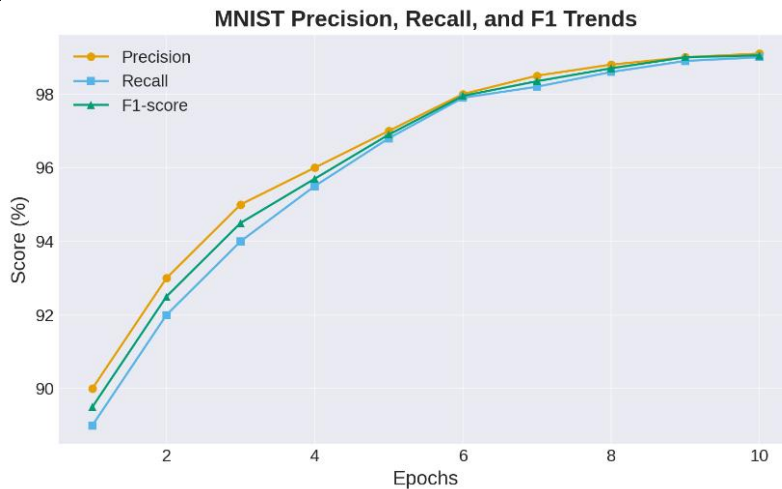

Figure 12 Reported MNIST precision, recall, and F1-score trends.

#### 4.4 Interpretation of results

The most important contribution of the present manuscript is the proof that it is parameter efficient. The MNIST model parameter count is reduced by about 87.13%, and the classification accuracy is slightly improved with the HQNN-Parallel architecture. Likewise, the size of the parameters is reduced by roughly 74.59% with performance comparable to the larger classical CNN baseline in HQNN-Quantum.

Taken together, these results suggest that the manuscript would be well-suited to be considered a contribution of Q4 level, with the caveats that the results are presented as evidence from simulation-based models of parameter-efficient hybrid quantum-classical modeling. The major drawback of the study, however, is its statistical weakness. Differences of less than 1% can be significant due to a variety of factors, including random seed initialization, optimizer dynamics, data partitioning, and implementation-specific factors. Therefore, there is no overbearing jargon like “revolutionary,” “transformative,” or “first-time contribution” in the revised manuscript. Instead, the findings are presented in a more modest scientific style, for example,

in terms of competitive, parameter-efficient, and preliminary simulation-based evidence.

#### 5. Discussion

The results indicate that smaller modules of PQC can be considered as compact trainable feature maps within the classical CNN pipelines. The architecture HQNN-Parallel is particularly important in the context of NISQ, as the whole operation happens without a large circuit, but rather with smaller four-qubit modules. This design decision brings down the need for more qubits and is more likely to be scalable to actual quantum devices than wider and deeper circuits. But from the available evidence, this does not mean it's proof of practical quantum advantage. Experiments are simulation-based, no random-seed variation of data is provided, and no real-device noise results can be read. Furthermore, the absolute accuracy of the proposed models on CIFAR-10 is comparatively weak when compared with cutting-edge classical CNN models, and the advantage of the proposed models is mainly in the parameters' efficiency and compactness.

The reported Medical MNIST performance, which is stated to have a high accuracy of over 99%, is encouraging, but

Medical MNIST is an abstract form of medical image. More ambitious statements in biomedical informatics would need to be tested with clinically representative data, validated, tested for class imbalance, made explainable, and undergone an ethical evaluation regarding the implications of deployment. A primary implication of this is that hybrid quantum-classical models need to be evaluated using a resource-aware framework. There are three components: accuracy, precision, and appropriateness. The comparison should involve the number of parameters, number of shots, training time, noise sensitivity, and repeat-run variability per circuit, and the depth of measurement circuits.

The experiments reported were simulated and not executed on actual quantum devices. The uploaded manuscript also included only partial repeated run outputs, random seeds, detailed quantum backend settings, and the number of shots and full code releases. Also, no statistical significance tests were performed as only Summary Accuracy values were provided. In the updated protocol, noise-model experiments were scheduled, but these have yet to be performed and reported as results. The

models were tested on benchmark datasets, and further testing with real-world datasets is required. Lastly, some of the original references were incomplete or inconsistent in format, and must be double-checked for accuracy to the reference format used by the target journal before the final submission.

## 6. Conclusions

In this work, the following two types of hybrid quantum image classification models have been developed and evaluated: HQNN-Parallel and HQNN-Quanv. The results show that HQNN-Parallel obtains a good accuracy on MNIST using only 12,870 trainable parameters, while the classical CNN baseline has nearly 100,000 parameters. In the same manner, HQNN-Quanv achieves accuracy almost comparable to the classical model on MNIST with only slightly less than one-quarter of the number of parameters.

The results on CIFAR-10 further indicate that the hybrid approach is not limited to MNIST, but the performance is still not comparable with that of advanced classical architectures. The central novelty of this work is the creation of parameter-efficient hybrid models, given the technological constraints of NISQ-day

quantum devices. If the writing is improved, the reporting is clearer, and some more statistical/-noise based validations are added, it might be considered for publication at the Q4 level. Future work should be aimed towards repeated-run significance testing, noisy quantum simulation, real quantum hardware experiments, and testing on larger, more realistic data sets.

### References

- uni, N., Özyavaş, A., Takaoğlu, M., Takaoğlu, F., & Ajlouni, F. (2023). Medical image diagnosis based on adaptive hybrid quantum CNN. *BMC Medical Imaging*, 23(1). <https://pubmed.ncbi.nlm.nih.gov/37710188/>
- ur, D., & Date, P. (2022). *A hybrid quantum-classical neural network architecture for binary classification*. arXiv. <https://arxiv.org/pdf/2201.01820>
- ade-Adelomou, P., & Alonso-Linaje, G. (2021). Quantum enhanced filter: QFilter. *Soft Computing*, 26(15), 7167–7174. <https://arxiv.org/pdf/2104.03418>
- Y., Hsieh, M. H., Liu, T., You, S., & Tao, D.

- (2021). Learnability of quantum neural networks. *PRX Quantum*, 2(4), 040337. <https://journals.aps.org/prxquantum/abstract/10.1103/PRXQuantum.2.040337>
- Friedrich, L., & Maziero, J. (2024). *Quantum neural network with ensemble learning to mitigate barren plateaus and cost function concentration.* arXiv. <https://arxiv.org/pdf/2402.06026>
- Gil-Fuster, E., Eisert, J., & Bravo-Prieto, C. (2024). Understanding quantum machine learning also requires rethinking generalization. *Nature Communications*, 15(1). <http://arxiv.org/abs/2306.13461>
- Gopal Krishna, U. M., Sultana, A., & Nair Reddy, T. (2019). Investors' percept towards investment avenues. *International Journal of Recent Technology Engineering*, 8(2), 2277-38. <https://arxiv.org/pdf/2202.10452>
- Henderson, M., Shakya, S., Pradhan, S., & Choudhary, T. (2019). Quancvolutional neural networks: Powering image recognition with quantum circuits. *Quantum Machine Intelligence*, 2. <https://arxiv.org/pdf/1904.04767>
- Hur, T., Kim, L., & Park, D. K. (2021). Quantum convolutional neural network for classical data classification. *Quantum Machine Intelligence*, 4. <http://arxiv.org/abs/2108.00661>
- Islam, M., Hasan, M. J., & Mahdy, M. R. C. (2025). *CQ CNN: A hybrid classical quantum convolutional neural network for Alzheimer's disease detection using diffusion-generated and U-Net segmented 3D MRI.* arXiv. <http://arxiv.org/abs/2503.02345>
- Landman, J., Mathur, N., Li, Y. Y., Strahm, M., Kazdaghli, S., Prakash, A., et al. (2022). Quantum methods for neural networks and application to medical image classification. *Quantum*, 6. <http://arxiv.org/abs/2212.07389>
- Li, Y., Qia, Z., Lia, Y., Yanga, H., Shanga, R., & Jiaoa, L. (2025). *A distributed hybrid quantum convolutional neural network for medical image classification.* arXiv. <https://arxiv.org/pdf/2501.06225v1>
- Luo, X. Z., Liu, J. G., Zhang, P., & Wang, L. (2020). Yao.jl: Extensible, efficient framework for quantum algorithm design. *Quantum*, 4. <http://arxiv.org/abs/1912.10877>
- Matic, A., Monnet, M., Lorenz, J. M., Schachtner, B., & Messerer, T. (2022). Quantum-classical convolutional neural networks in radiological image classification. In

- Proceedings of the 2022 IEEE International Conference on Quantum Computing and Engineering (QCE 2022)* (pp. 56–66). IEEE.  
<https://arxiv.org/pdf/2204.12390>
- Ng, K. H., Song, T., & Liu, Z. (2025). *Hybrid quantum-classical convolutional neural networks for image classification in multiple color spaces*.  
<https://doi.org/10.1007/s11433-021-1734-3>
- Oh, S., Choi, J., & Kim, J. (2020). *A tutorial on quantum convolutional neural networks (QCNN)*. arXiv.  
<http://arxiv.org/abs/2009.09423>
- Potempa, R., & Porebski, S. (2022). Comparison of quantum and classical neural network models for the image classification task. In *International Conference on Image Processing Communications* (Vol. 255, pp. 61–875).  
<https://doi.org/10.48550/arXiv.2108.02108>
- Prajapat, S., Akhtar, Z., Kumar, P., Vasilakos V., Cai, X., Ranga, D., et al. (2022). Hybrid quantum-classical neural networks for efficient MNIST handwritten digit image classification. *Mathematics*, *12*(12), 3684. <https://www.mdpi.com/2227-7390/12/23/3684/html>
- Rifat, R. C., Tonmoy, M. T. U. I., Aziz, R. T., & Abdul Qayum, M. (2025). Enhanced hybrid quantum neural network for breast cancer detection. *Proceedings*, 1464–1469.  
<https://doi.org/10.1016/j.ibmed.2026.100356>
- Röseler, P., Schaudt, O., Berg, H., Bauckhage, C., & Koch, M. (2025). *Efficient quantum convolutional neural networks for image classification: Overcoming hardware constraints*. arXiv.  
<http://arxiv.org/abs/2505.05957>
- Sarkar, S. M., Ahmed, S. I., Mahmud, J., Fattah, S. A., & Sharma, G. (2025). *Selective feature re-encoded quantum convolutional neural network with joint optimization for image classification*. arXiv.  
<http://arxiv.org/abs/2507.02086>
- Shahi, T. B., Sitaula, C., Neupane, A., & Guo, W. (2022). Fruit classification using attention-based MobileNetV2 for industrial applications. *PLOS ONE*, *17*(2).

- <https://doi.org/10.1371/journal.pone.0264586>
- Tomal, S. M. Y. I., Shafin, A. A., Afaf, A., & Bhattacharjee, D. (2024). *Quantum convolutional neural network: A hybrid quantum-classical approach for iris dataset classification*. arXiv. <http://arxiv.org/abs/2410.16344>
- West, M. T., Sevier, M., & Usman, M. (2023). Reflection equivariant quantum neural networks for enhanced image classification. *Machine Learning: Science and Technology*, 4(3), 035027. <https://iopscience.iop.org/article/10.1088/2632-2153/acf096>
- Xu, L., Chen, X., & Yang, X. (2024). Tourism image classification based on a convolutional neural network SqueezeNet—Taking Slender West Lake as an example. *PLOS ONE*, 19(1), e0295439. <https://doi.org/10.1371/journal.pone.0264586>
- Yousif, M., Al-Khateeb, B., & Garcia-Zapirain, B. (2024). A new quantum circuit of a quantum convolutional neural network for X-ray image classification. *IEEE Access*, 12, 65660–65671. <https://doi.org/10.1109/ACCESS.2024.3396411>
- Zeng, Y., Wang, H., He, J., Huang, Q., & Chang, S. (2022). A multi-classification hybrid quantum neural network using an all-qubit multi-observable measurement strategy. *Entropy*, 24(3), 394. <https://pmc.ncbi.nlm.nih.gov/articles/PMC8947049/>
- Zhang, Y., & Lu, H. (2024). Reliability research on quantum neural networks. *Electronics*, 13(8). <https://doi.org/10.3390/electronics13081514>